

Hydrogen Trapping through Designer Hydrogen Spillover Molecules with Reversible Temperature and Pressure- Induced Switching

P.I.: Angela D. Lueking, Ph.D.

Co-PI: Jing Li, Ph.D.*

Presenter: Cheng-Yu Wang

The Pennsylvania State University; *The Rutgers University

May 15, 2013

ST024

Overview

Timeline

- Project start date: Feb. 2009
- Project end date: Nov. 2013
- Percent complete: 87%

Budget

- Total project funding
\$2,166,895
 - DOE share: \$1,614,000
 - Contractor share: \$552,895
- Funding received in FY12:
\$300K
- Funding for FY13: \$0K

Barriers

- Gravimetric Capacity
- Min/max delivery temperature
- Max delivery pressure from tank
- Adequate charge/discharge kinetics
- Reproducibility / reusability

Partners

- MOF Synthesis: Prof. Jing Li (Rutgers) Co-PI
- DFT: George Froudakis, University of Crete
- Catalyst samples: Institute of Nuclear Energy Research, Taiwan

Relevance

The **overarching objective** is to synthesize designer microporous metal-organic frameworks (MMOFs) mixed with catalysts to enable H-spillover for H₂ storage at 300K-400K and moderate *P*_s.

In the past year (March 2012 – March 2013), our objective has been to focus on synthesis and optimization of one catalyst-doped MMOF, including:

- A. MOF chosen based on chemical functionality, ability to **introduce dissociation catalyst for room temperature adsorption**, and **expected uptake if fully hydrogenated** as predicted by density functional theory
- B. Stability of MOF (XRD, surface area) after various catalytic doping techniques
- C. Improved reproducibility of synthesis and subsequent H₂ uptake after catalytic doping
- D. **Identify kinetic barriers to reach thermodynamic predicted capacity of doped MOF**
- E. **Comparative study of chosen MOF, with 2 others from previous studies**
- F. Spectroscopic verification of reversible spillover
- G. Preliminary studies for **direct-doping via designed surface chemistry of MOF to interact with catalyst precursors**
- H. **Verified accuracy** of differential and gravimetric methods for confirming adsorption capacity

Approach: Introduce Dissociation Catalyst into MOFs to Hydrogenate structure

Our approach relies on introduction of H_2 dissociation catalysts to enable dissociative chemisorption at ambient temperature.

MOFs were selected due to the ability to tailor surface chemistry and structure, so these variables may be carefully controlled in material synthesis/design. Our vision is that carefully controlling these properties will significantly increase reproducibility of material performance, and allow for material optimization.

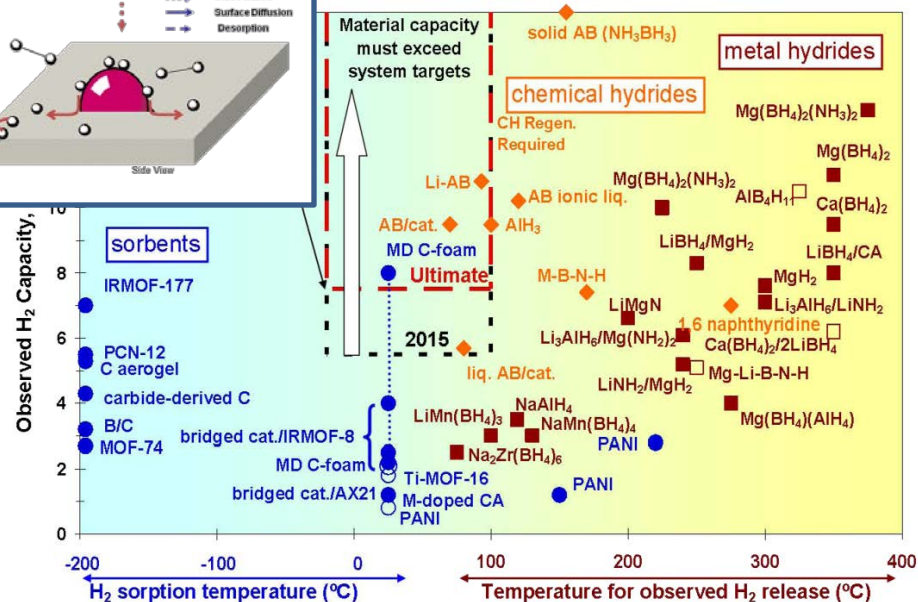
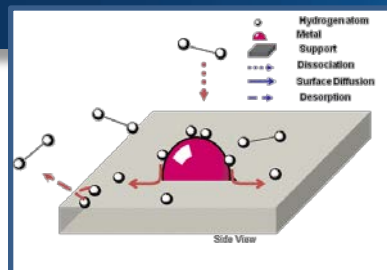

DOE: G. Thomas (2007), G. Sandrock (2008), B. Bowman (2009)

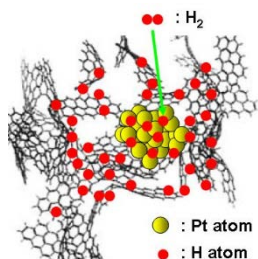

Pt/AC

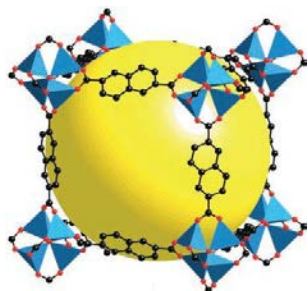
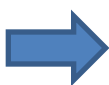

IRMOF8 (baseline)

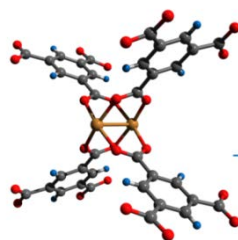

CuBTC

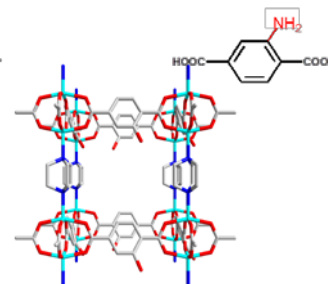

MOF-N1

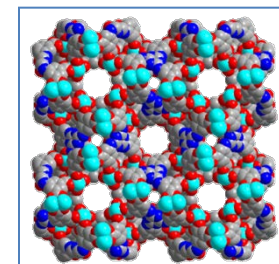

MOF-N2

Approach:

Improved Differential Adsorption Measurements combined with Spectroscopic Verification

Spectroscopic evidence has conclusively demonstrated reversible room temperature hydrogenation for carbon-based materials¹ (right). Spectroscopy can also be used to understand which surface sites in the MOF are hydrogenated via the spillover process² (bottom right).

We are now incorporating spectroscopic measurements into all material characterization, thereby supplementing our high-pressure differential measurements.

Previously, we have improved volumetric methods 10-fold using propagation of error in equipment design of a differential unit.³

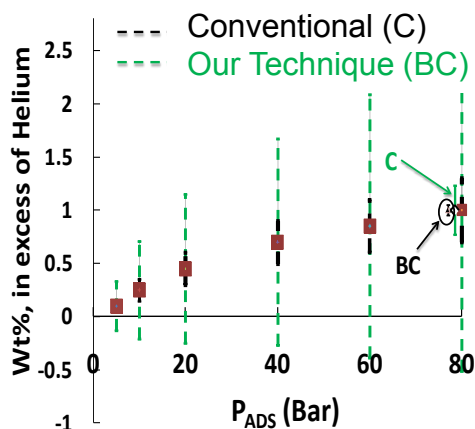
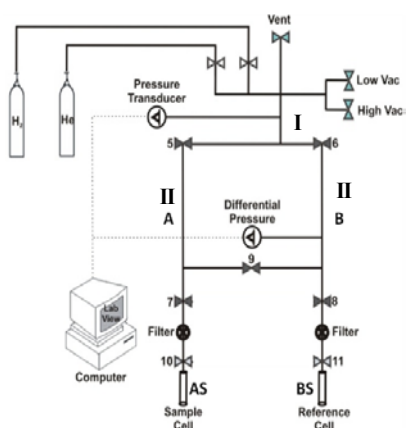

³Lueking, Wang, et al., Submitted, 2013.

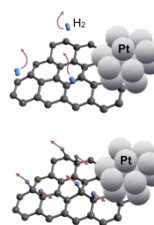

¹Lueking et al., *Nano Lett.* 13, 137-141, 2013.

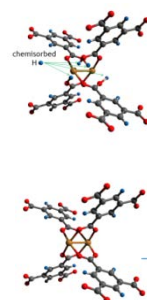
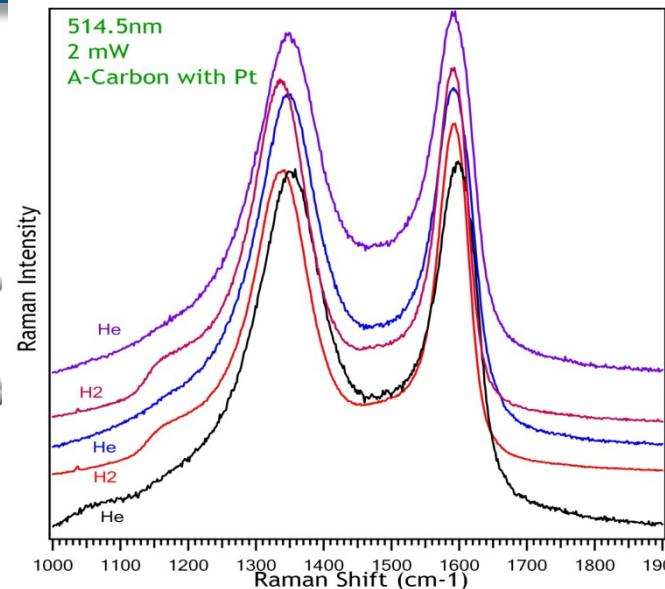

²Lueking, Li, et al., *J. Phys. Chem. C*, 116 (5), 3477-3485, 2012.

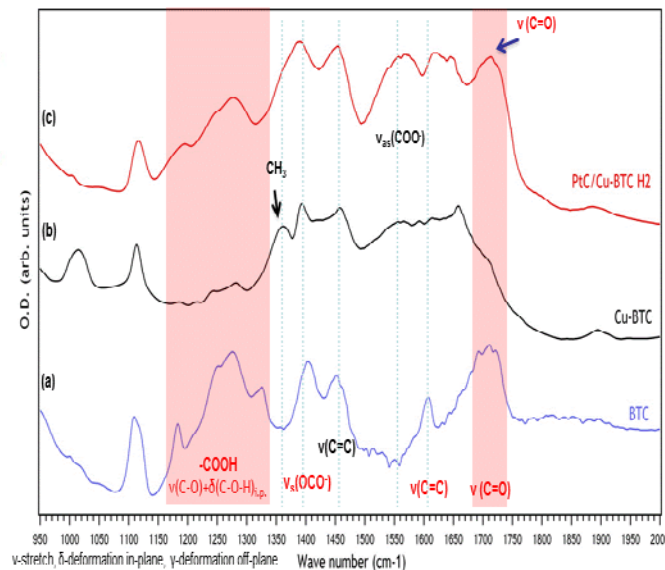

Milestones and Go/No-Go Decision Points:

Tasks / Milestones

1. Optimization of MOF for Hydrogen Spillover

A single MOF was chosen in June 2012 for study. It was selected due to pore structure, stability, and surface chemistry that facilitated multiple catalytic doping methods.

2. Incorporation of Catalysts into MOF Framework

We have identified a technique that keeps MOF structure intact. Additional work is needed to increase kinetics of H transfer from the catalyst to the MOF.

3. Exploring MOF Structural Changes Induced by Pressure and Hydrogen Spillover

We have published baseline data, and continue to explore MOF structure after hydrogenation via hydrogen spillover.

4. Hydrogen Spillover Reproducibility, Characterization, and Measurement

We have verified adsorption method precision and have included spectroscopic validation.

Go/No-Go decisions (FY13): Exceed 3 wt% reversible (<80 °C, <30 minutes) H₂ storage through the use of the “hydrogen spillover” mechanism, MOF material, or a combination of the two as proposed at moderate temperatures and pressure (i.e. 300-400 K and <100 bar) with anticipated system penalties as measured at an independent laboratory of DOE’s choice. Also, Demonstrate hydrogen spillover mechanism provides a means to increase ambient temperature hydrogen uptake of the MOF and/or carbon support by 50%.

Current Status: After promising low-pressure H₂ data, high-pressure data is plagued by kinetic limitations, which are apparently pressure- and history-dependent. DFT calculations suggest 3 wt% is thermodynamically feasible.

Technical Accomplishments—Previous year, 2012: Exploratory study of MOF Doping Methods

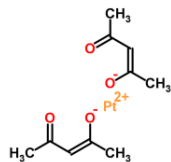
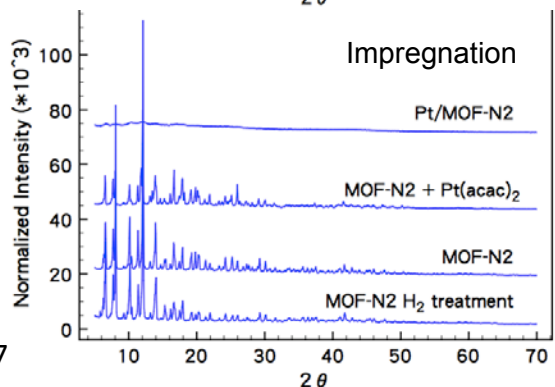
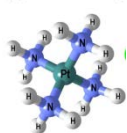
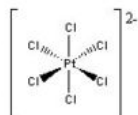
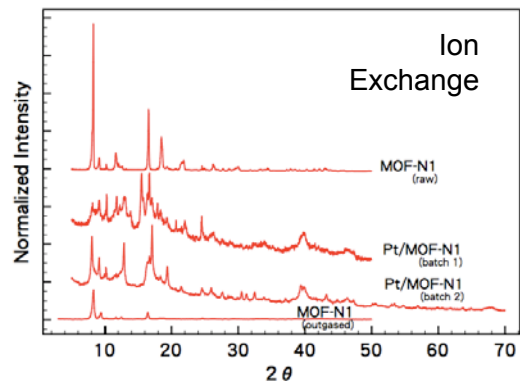
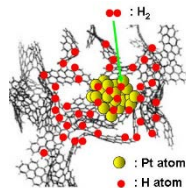
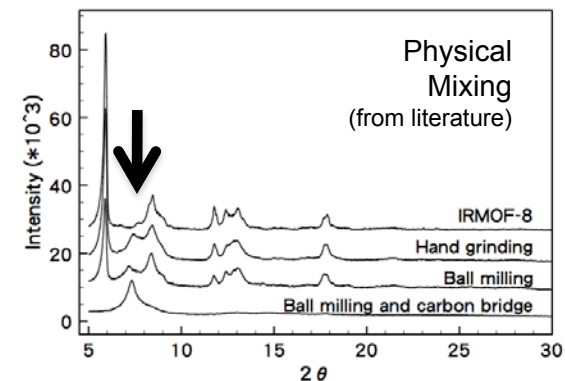

Evolution

Structural degradation of MOF (left) led to inconsistent hydrogen uptake (right).

Distinguishing characteristics of “good” doped-MOF samples unclear from XRD/SSA.

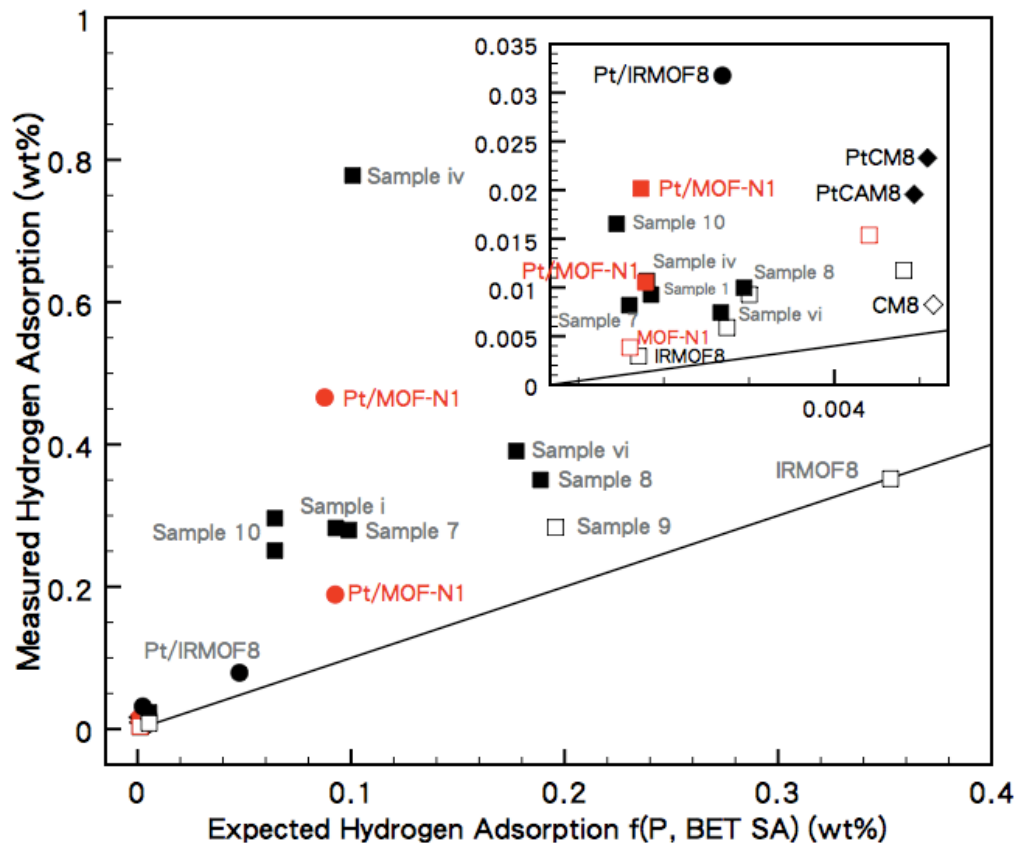

Technical Accomplishments: MOF Selection, Synthesis, and Optimization

MOF-N2 is chosen for its

- high surface area
- high thermal stability
- high water stability
- High baseline uptake via physisorption at 77K
- high density of functional sites for H₂ spillover

In-situ synthesis route is developed to pre-bridge the catalyst (Pt/AC), and experimental conditions are modified and optimized to produce well dispersed samples.

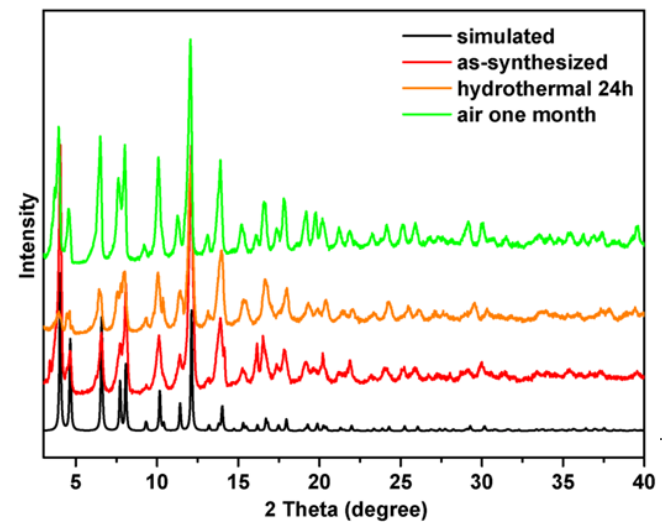
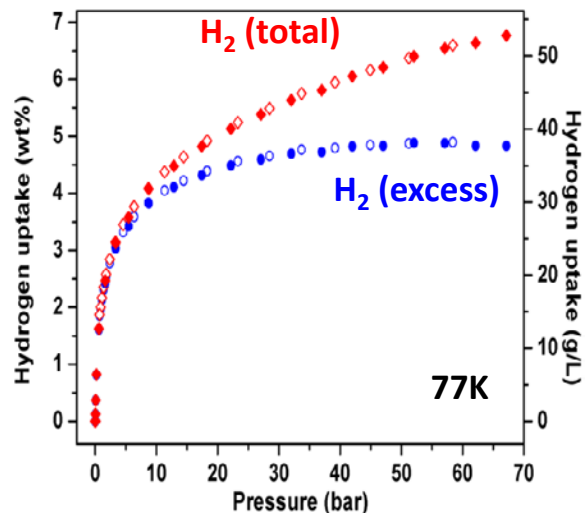
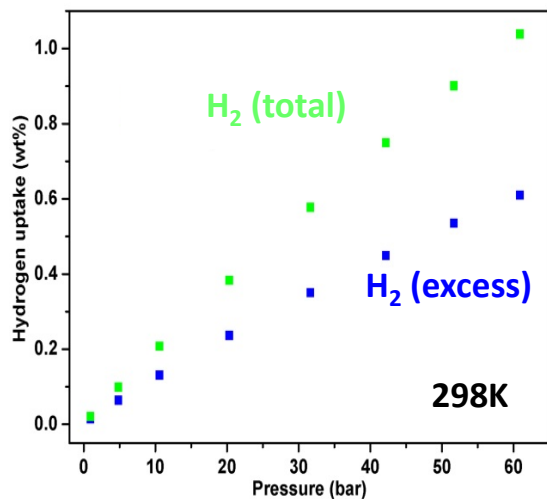
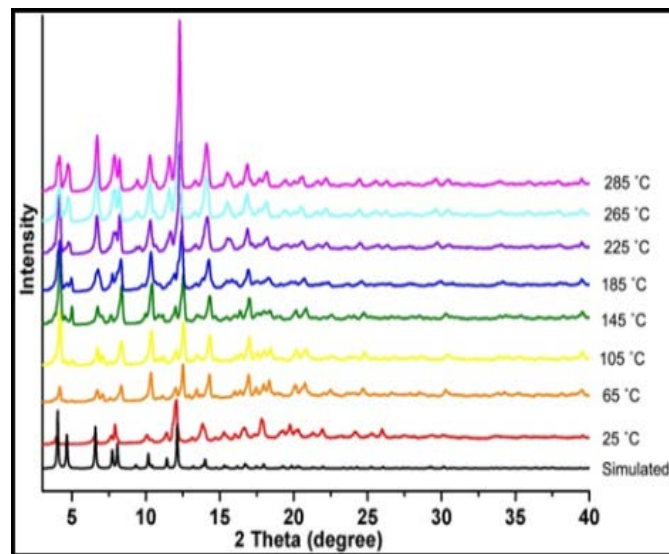

Improved "PB" doping technique (1)

"PB" Technique

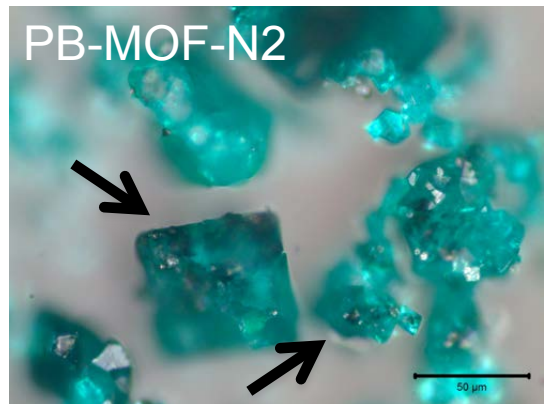
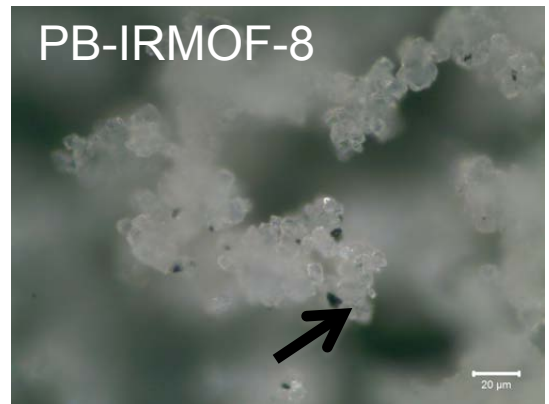
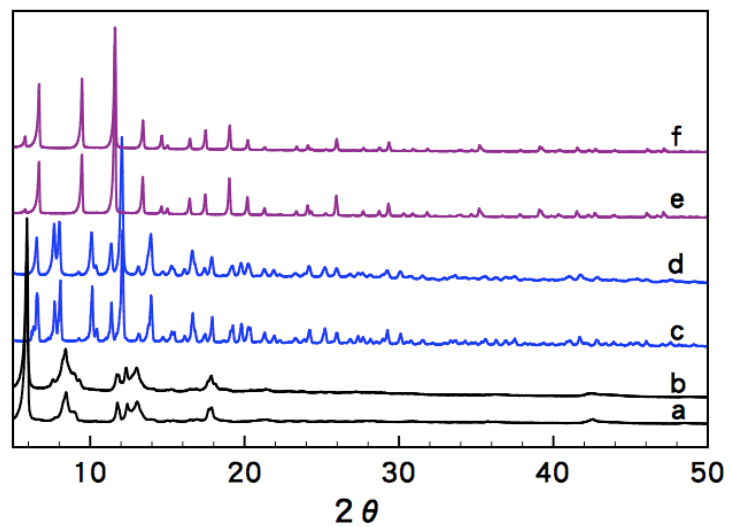
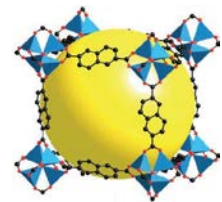
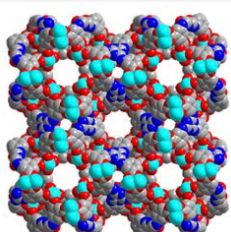
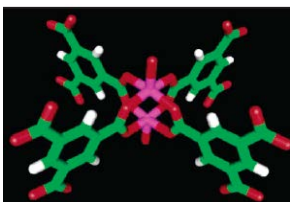
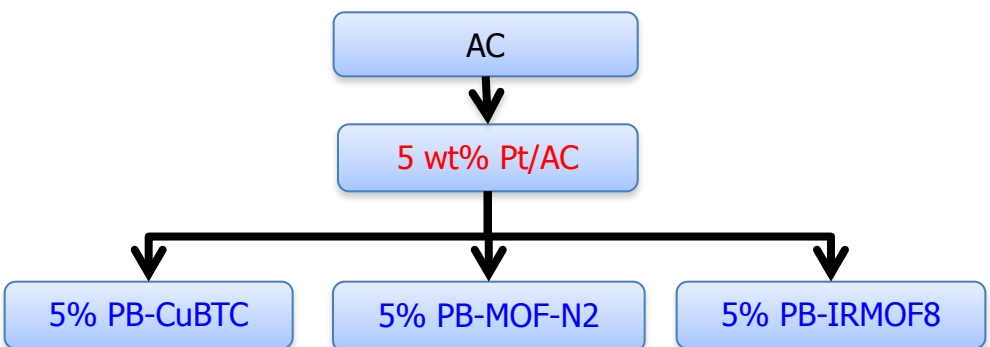

PB doping technique maintains XRD pattern and disperses catalyst into MOF.
Pt is still on carbon

Technical Accomplishments:

Improved “PB” doping technique (2)

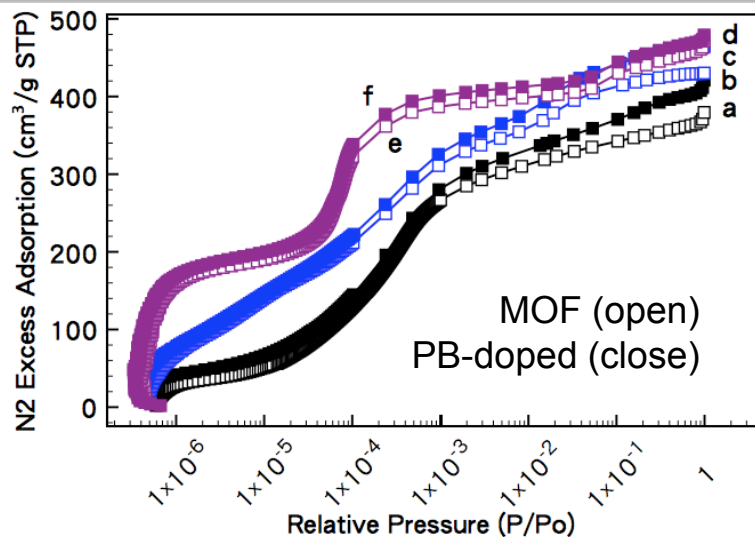

Left: PB doping technique maintains porosity and surface area, increasing relative to undoped MOF.

Below: Past reports of MOF doping indicate instability and loss of surface area

Samples	SSA _{BET} (m ² /g)	SSA ratio	V _{total} ¹ (cc/g)	Medium pore width ² (Å)
IRMOF-8 (a)	1384	N/A	0.587	10.02
PB-IRMOF-8 (b)	1471	106%	0.651	10.11
MOF-N2 (c)	1638	N/A	0.665	10.93
PB-MOF-N2 (d)	1748	107%	0.718	11.09
Cu-BTC (e)	1772	N/A	0.741	10.24
PB-Cu-BTC (f)	1711	97%	0.729	10.30

Doping Technique Sample Name from PSU *Literature Report	Comparison of XRD Quality (Before vs. After Doping)	BET SSA (m ² /g) Before/After doping (%)
<u>Physical Mixing / Ball Milling</u> PtC/IRMOF8-iv	New Peak	1384 / 380 (28%)
<u>Bridging Technique</u> PB-IRMOF8-x *PtC/IRMOF1—Ref 1 *PtC/IRMOF8—Ref 1 *PtC/COF1—Ref 2 *PtC/CuBTC—Ref 2 *PtC/MIL101—Ref 2	Different ND† ND ND ND ND	1384 / 310-760 (22-55%) 1021 / 890 (87%) 548 / 466 (85%) 628 / 582 (93 %) 1296 / 1116 (86%) 3023 / 2580 (85%)
<u>Direct Doping</u> Pt/IRMOF8 Pt/MOF-N1 *Pt/IRMOF8-Ref 3 *Pd/MIL101(Al)—Ref 4	Missing Peak Different Intact Intact	1384 / 674 (49%) 1250 / 350-370 (30%) 1430 / 1175 (82%) 1200 / 380 (31%)
<u>Prebridging Technique</u> PB-IRMOF8 PB-IRMOF8 PB-MOF-N1 *PtC/IRMOF1—Ref 5 *PtMWNT/IRMOF1-Ref 6	Intact Intact Intact Intact Intact	1384 / 1471 (106%) 1384 / 1421 (103%) 1638 / 1748 (107%) 1820 / 730 (40%) 1758 / 1692 (96%)

Technical Accomplishments:

Promising low pressure uptake of PB-MOF-N2

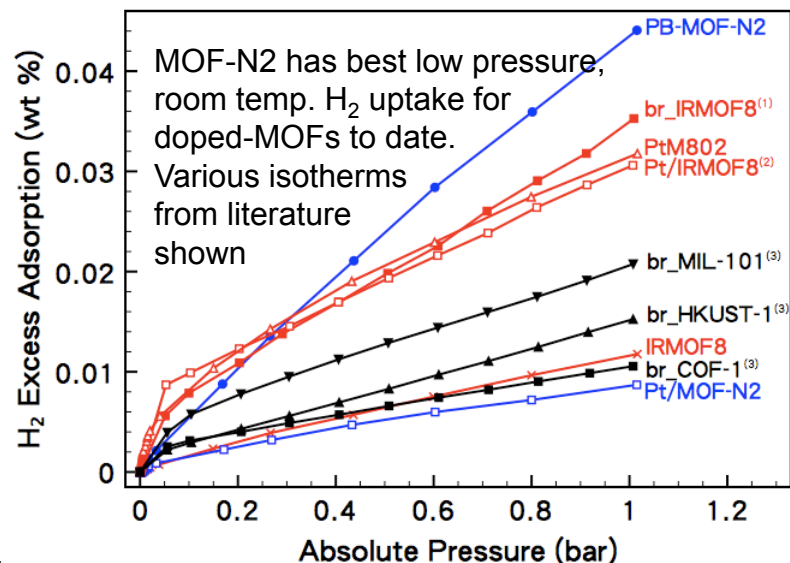
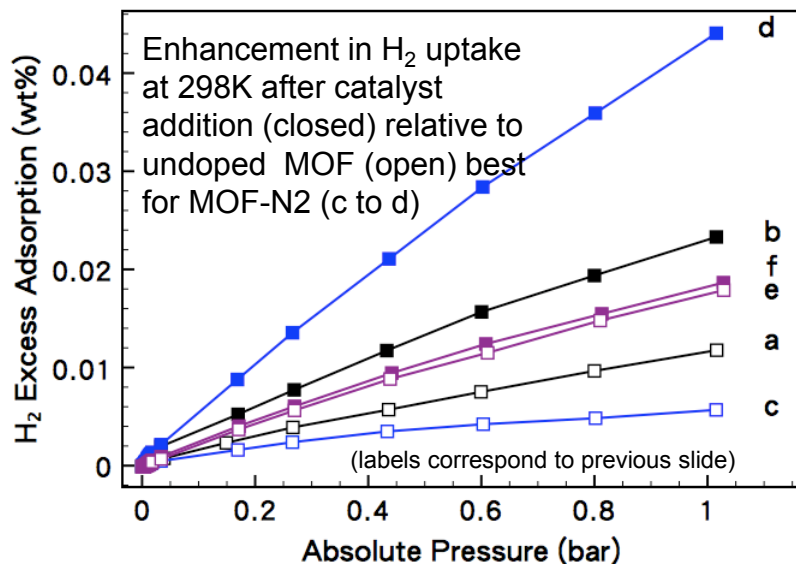

Our uptake goal is to identify conditions in which MOF-N2 can be fully hydrogenated. Assuming we identify these conditions, we presume MOF chemistry can be tailored at a later date to increase capacity.

At low pressure and ambient temperature, PB-MOF-N2 has the best enhancement relative to the undoped MOF (considering MOF-N2, CuBTC, IRMOF8; see upper left). The PB-MOF-N2 isotherm is the highest low P uptake to date, relative to other published data (lower left).

Preliminary DFT calculations suggest reversible[†] hydrogenation ($\Delta E_{\text{avg}} = -0.55 \text{ eV}$) and up to 3.25 wt% uptake.

Only minor strain energy introduced by hydrogenation of the ligand of the MOF.

[†] Target is $-0.6 < dE < -0.2 \text{ eV}$.
Yakobson et al. ACS Nano, 3, 1657, 2009

Literature isotherms (lower left) from
(1) *J. Am. Chem. Soc.* 2006, 128, 8136-8137.
(2) *J. Phys. Chem. C.* 2011, 115, 4793-4799.
(3) *AIChE Journal.* 2008, 54, 269-279.

Technical Accomplishments: Reproducibility

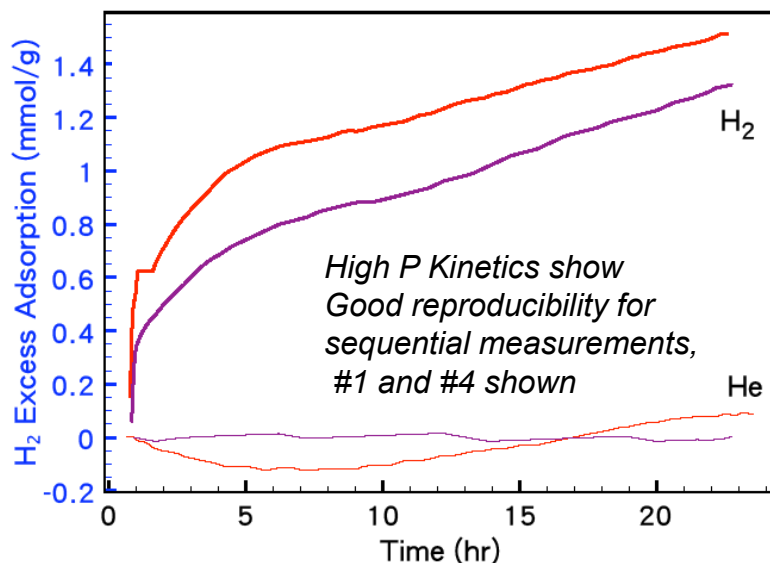
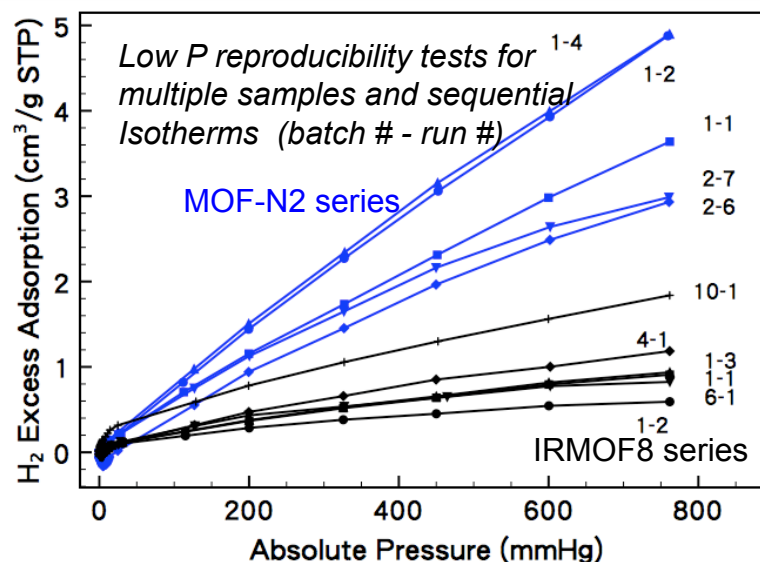
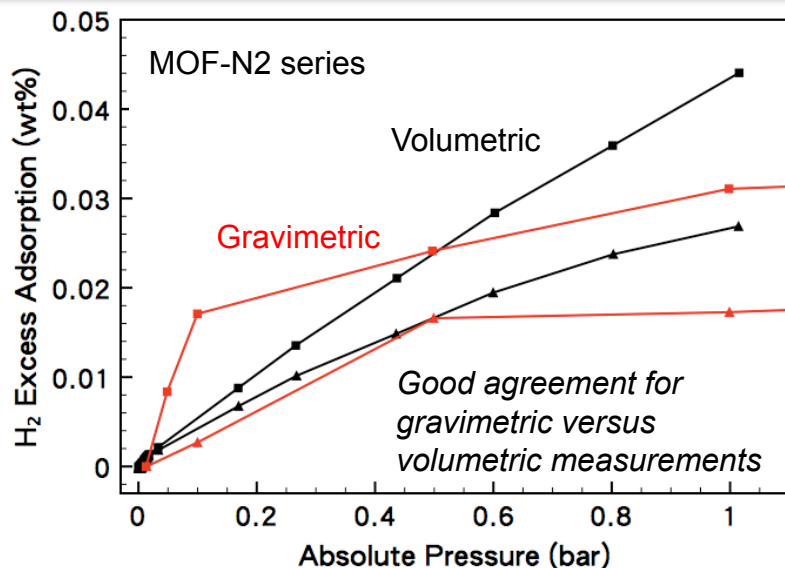

Greater variability due to synthesis of MOF (as assessed by surface area), and H₂ exposure history rather than catalyst doping / insertion.

Low pressure H₂ uptake relatively independent of surface area, but high pressure kinetics are dependent upon exposure history.

PENNSTATE

Technical Accomplishments:

Unusual pressure/history -dependent kinetic limitations

H ₂ Uptake, 298K (wt%)	1 bar	70 bar (or 20 bar [†])
AC	0.0185	0.646
Pt/AC_2	0.0362	0.791
IRMOF8	0.0118	0.357 0.337
PB-IRMOF8	0.0247	0.317
MOF-N2	0.00568	0.351
PB-MOF-N2	0.0441	0.477 (batch1) 0.555 (batch2) 0.334 (batch2) 0.305 (batch3) 0.292 (batch3)
CuBTC	0.0179	0.17 [†]
PtAC/CuBTC	0.0186	0.61 [†]

$$D = \frac{1}{z} v_e \alpha^2 e^{-E_a/kT}$$

$$= 10^{-13} \text{ cm}^2/\text{s} \quad (E_a = 0.6 \text{ eV})$$

$$= 10^{-20} \text{ cm}^2/\text{s} \quad (E_a = 1 \text{ eV})$$

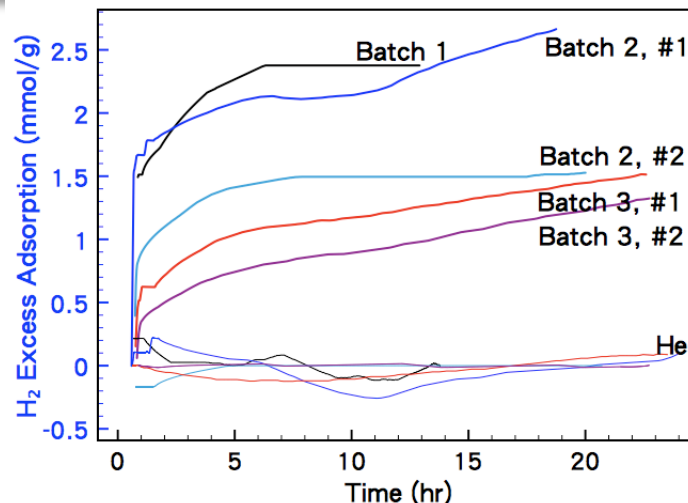

Adsorption not complete after 80 hours at 298 K!
Recent in situ Raman and DFT calculations suggest diffusion must occur in chemisorbed state.

With calculated diffusivity (bottom, left) it would take ~0.16 sec when $E_a = 0.6 \text{ eV}$ (240 hr when $E_a = 1 \text{ eV}$) to diffuse 1 nm. Thus, E_a of surface diffusion should be a primary consideration in design of spillover materials.

Kinetic study in gravimetric equipment reveals prior activation / H₂ exposure enhances kinetics

Technical Accomplishments: Spectroscopic evidence for Reversible Spillover to ligand (1): XPS, Cu 2p_{3/2}

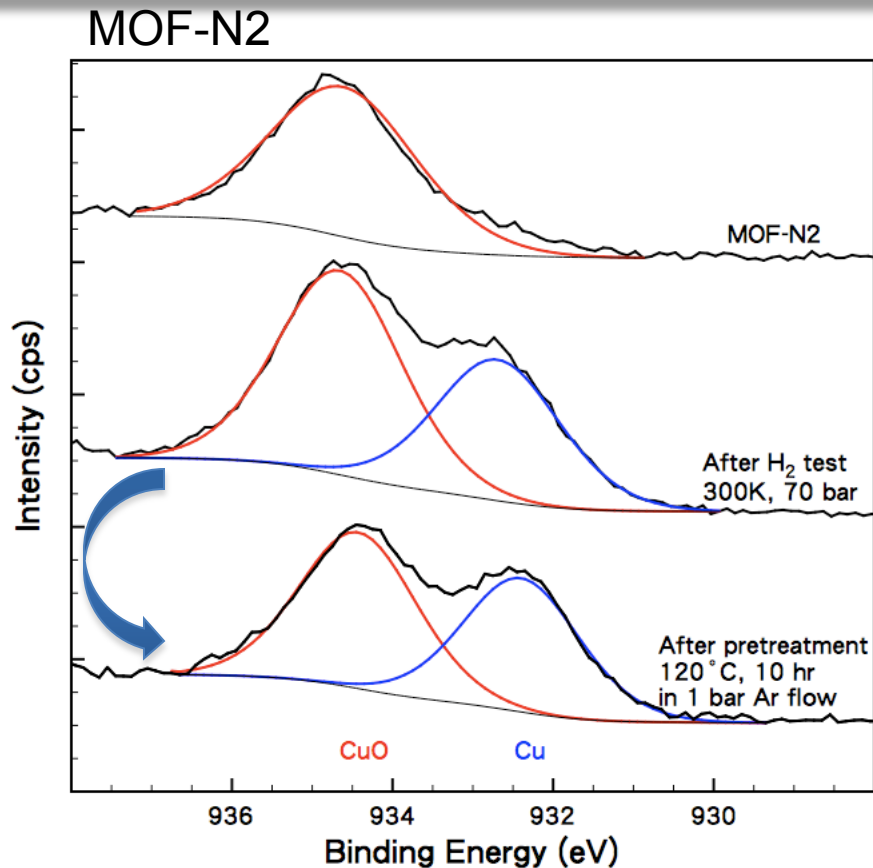

Cu reduction observed after H₂ exposure.

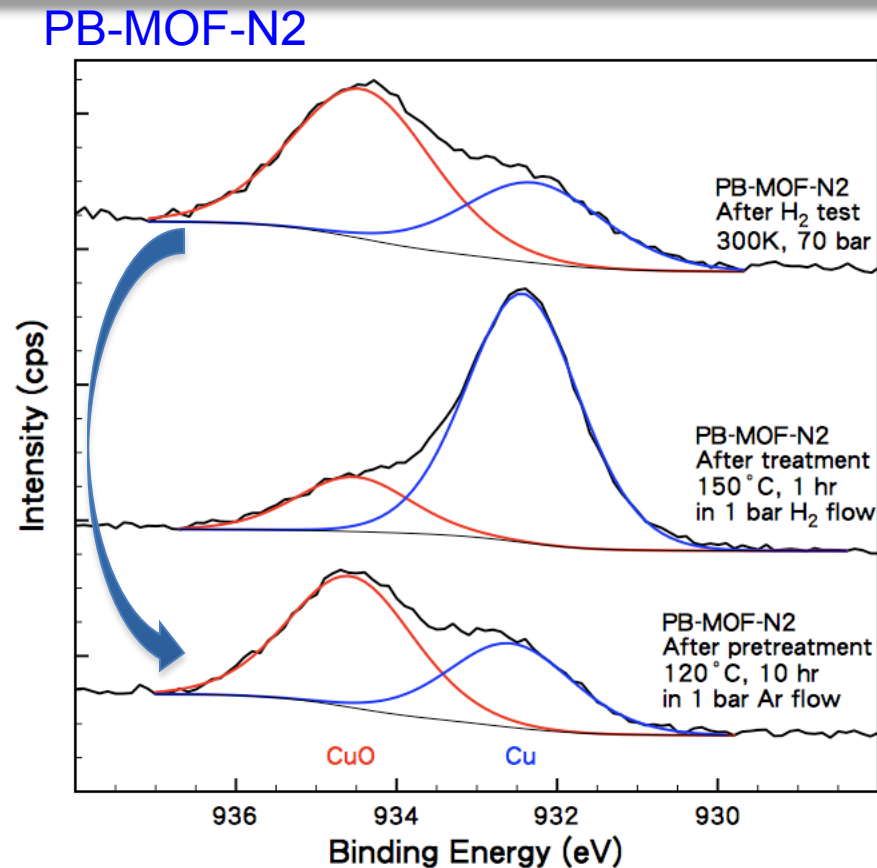

Same irreversible Cu reduction observed
after H₂ exposure.

High temperature Pt “reduction” further
reduces Cu.

Technical Accomplishments: Spectroscopic evidence for Reversible Spillover to ligand (2): XPS, N 1s

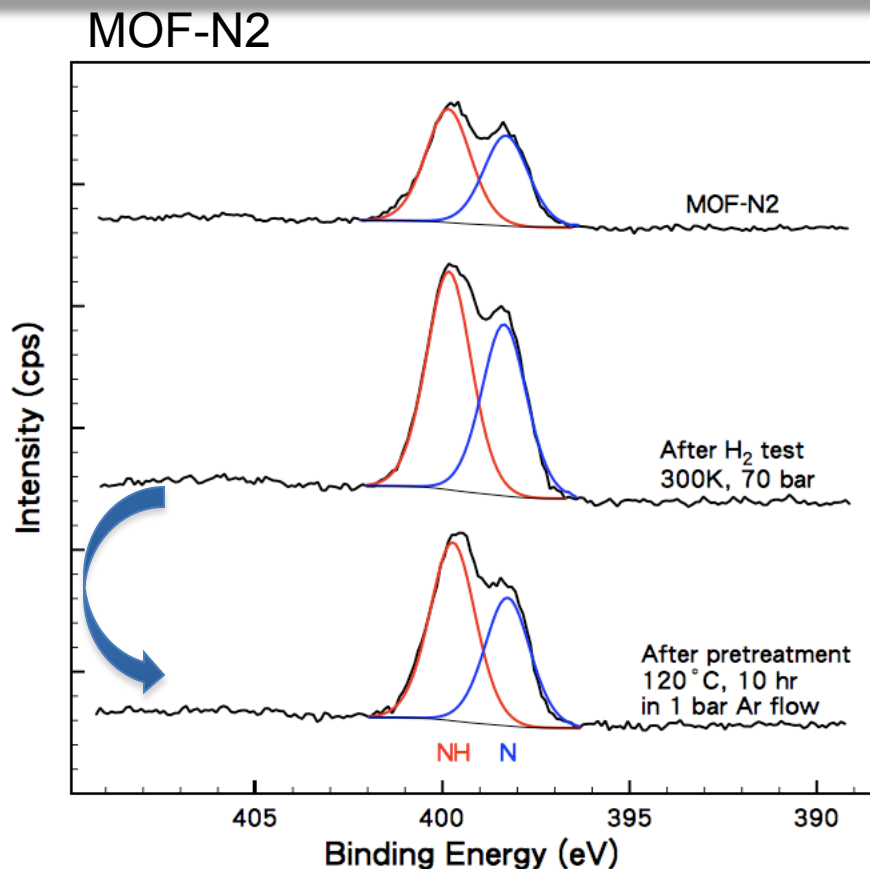

No effect of H₂ exposure on N spectra.

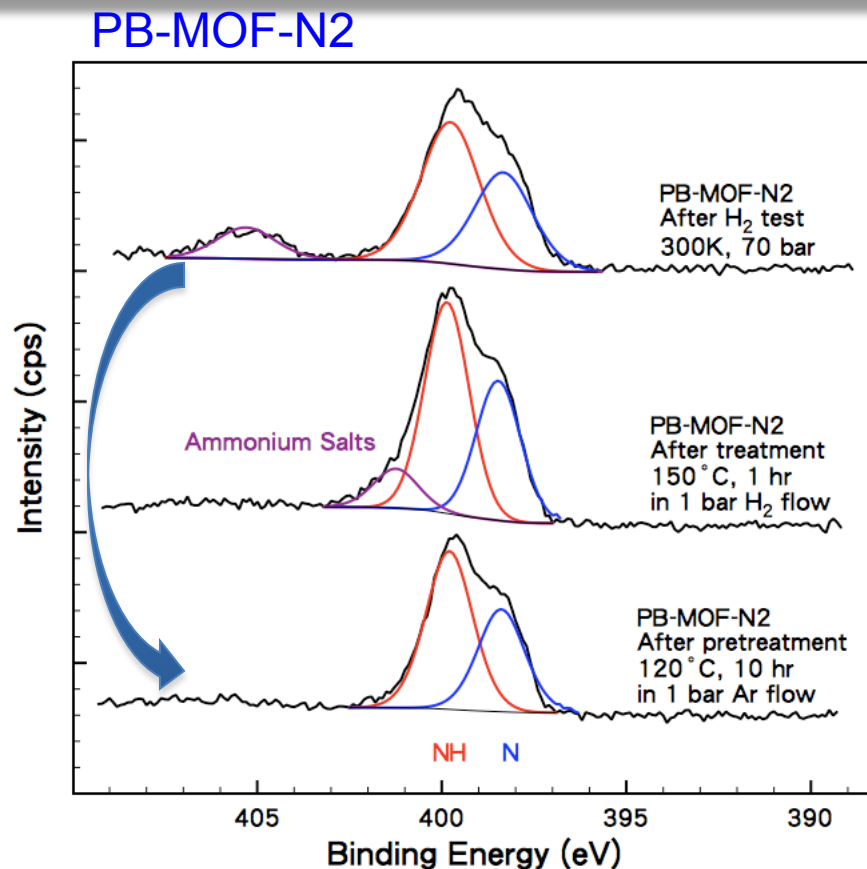

Reversible shift in N spectra after room temperature H₂ exposure.

Shift in N spectra is dependent upon H₂ exposure temperature.

Technical Accomplishments:

Structure stable after hydrogenation, except if exposed to high temperature H_2

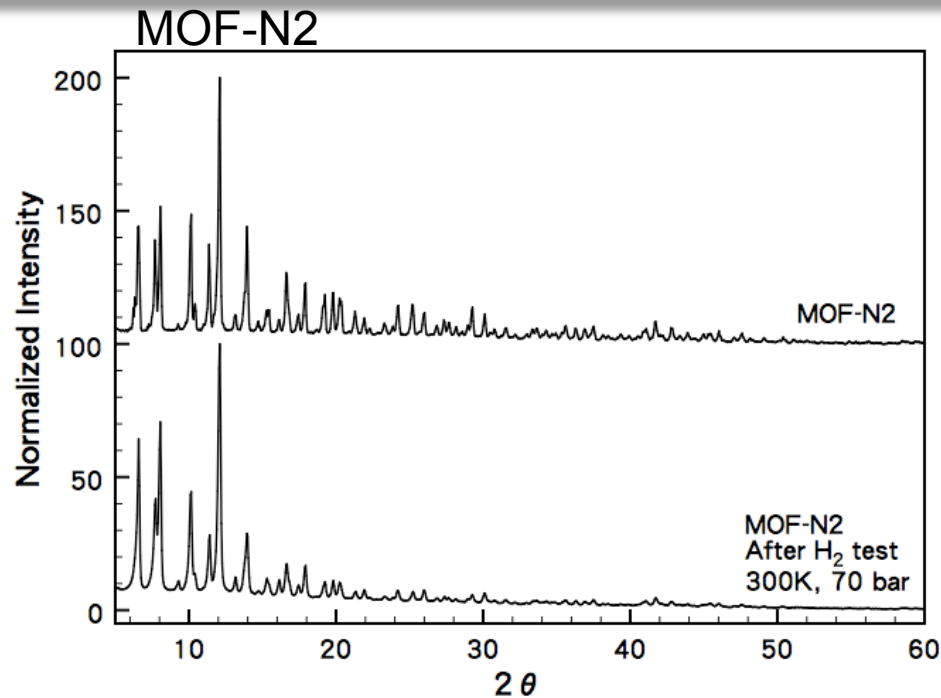

No effect of room temperature H_2 exposure on XRD pattern of MOF-N₂; PB-MOF-N₂ has minor difference in relative intensities.

High temperature H_2 reduction (150°C, 1 hr) leads to bulk Cu formation; Intensities of MOF-N₂ pattern is reduced.

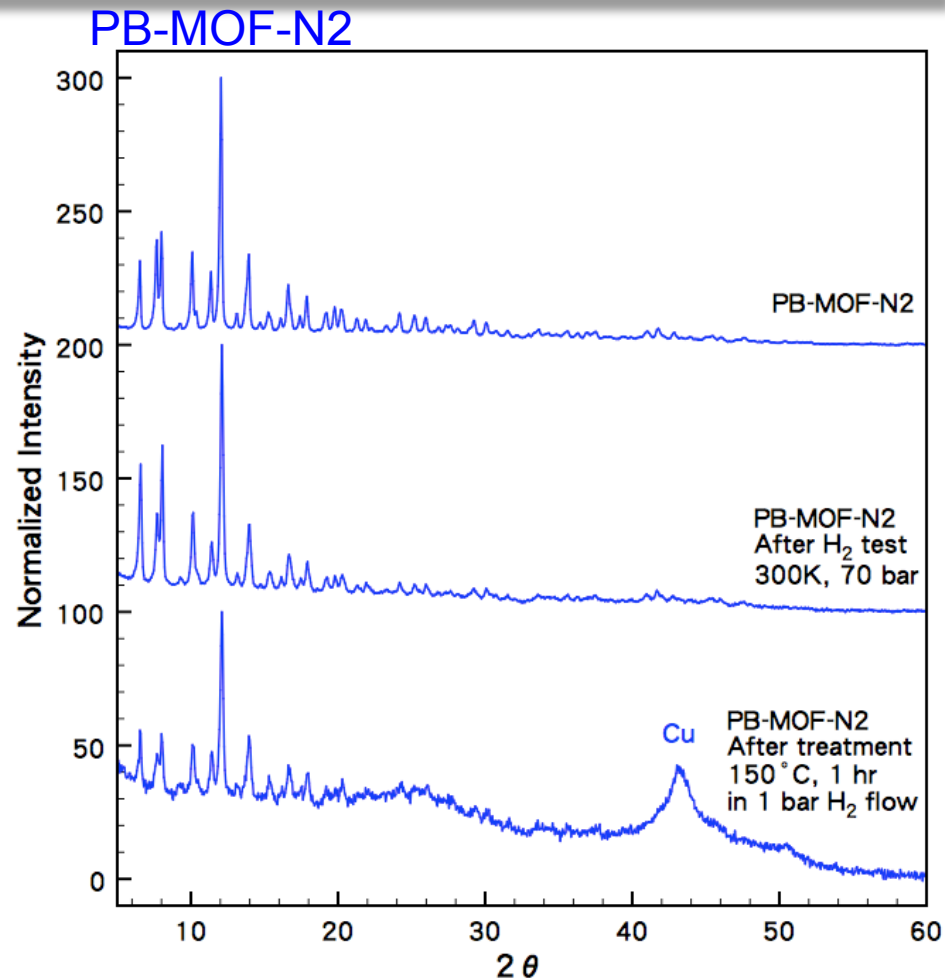

Technical Accomplishments: Spectroscopic evidence for Reversible Spillover to ligand (3): DFT

H added	Incremental Binding energy per H (eV/H ₂)	Overall / average binding energy (eV/H ₂)
1	1.24	1.24
2	-0.99	0.15
3	-0.65	-0.12
4	-1.47	-0.46
5	0.56	-0.25
6	-3.07	-0.72

DFT studies suggest sp^2 carbon ring is hydrogenated prior to N groups, thus spectroscopic evidence for N-H formation suggests C-H formation is also likely.

In situ methods are needed to verify this.

Technical Accomplishments: Spectroscopic evidence for Reversible Spillover to ligand (4): FTIR

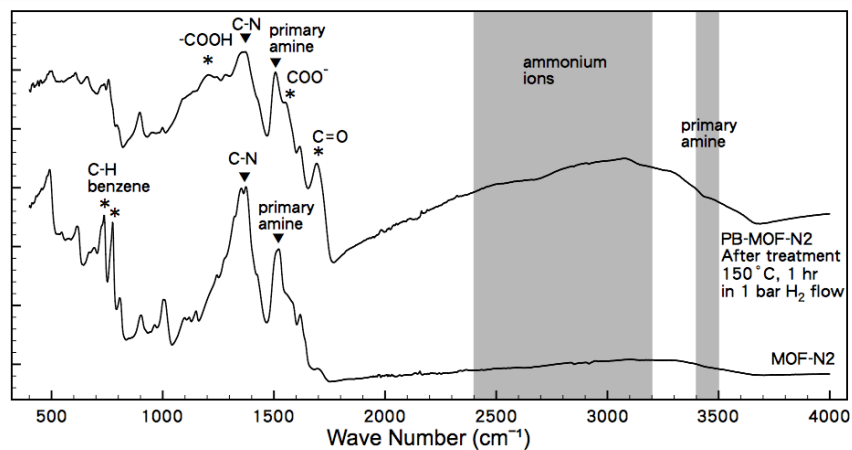

FTIR of as-received MOF-N2 (bottom) versus extreme hydrogenation (at high temperature).

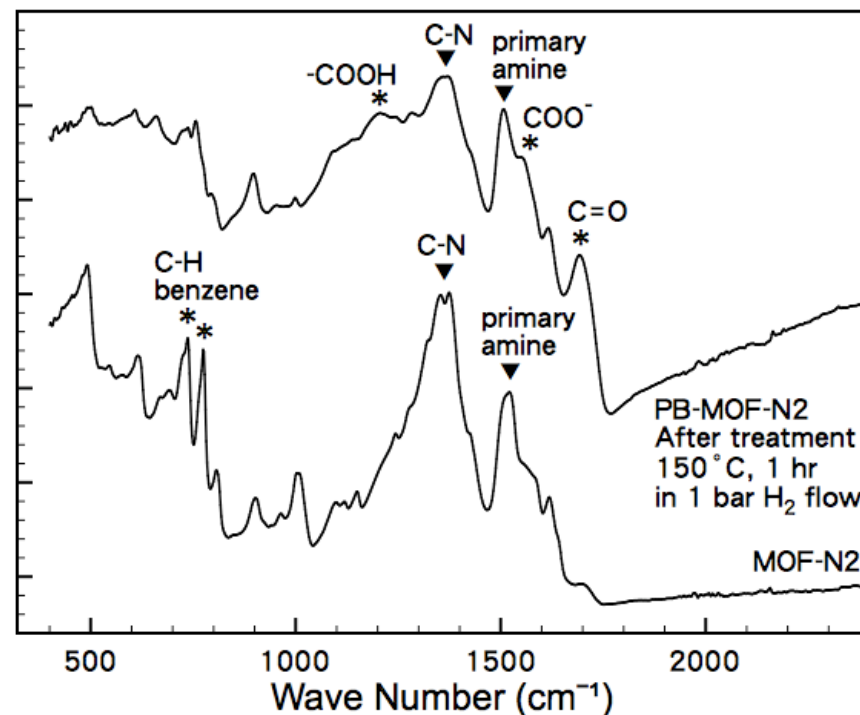

Formation of ammonium observed in FTIR, consistent with XPS.

Hydrogenation of COOH, consistent with observation of Cu formation in XRD & XPS; consistent with previous CuBTC results.

Technical Accomplishments: Finalized quantitative analysis of benefits of differential adsorption unit.

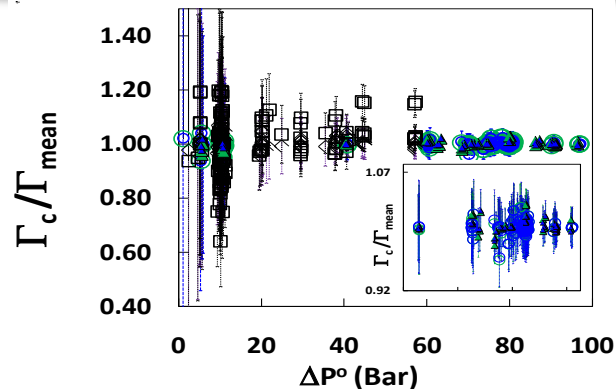

Systematic error in volume calibration plagues many volumetric measurements. This is not fully addressed in DOE recommended methods.

In 2013, we have published¹ our efforts to greatly increase the accuracy of high-pressure volumetric measurements, which are highly prone to error. Using quantitative multivariate analysis, we demonstrate how a differential unit significantly decrease the sensitivity to volume error and/or sample density, showing 10- to 250-fold improvement over similar conventional units. This is in addition to their inherent advantage to handle leakage, gas compressibility, and temperature gradients. Hydrogen adsorption to GX-31 superactivated carbon at 298K is measured within 0.05 wt% for a 100 mg sample, when experimental volume calibration is determined within ~1%. We also provide a framework for optimizing the design of a volumetric adsorption unit.

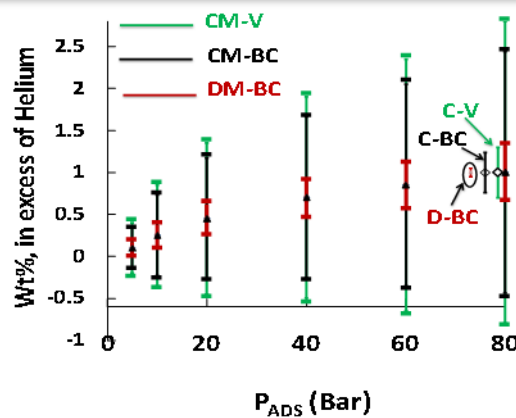

Advantages of a differential unit arise due to higher accuracy of differential pressure transducer and insensitivity to volume error.

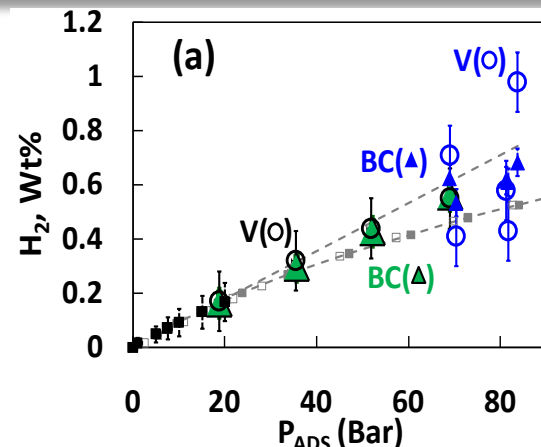
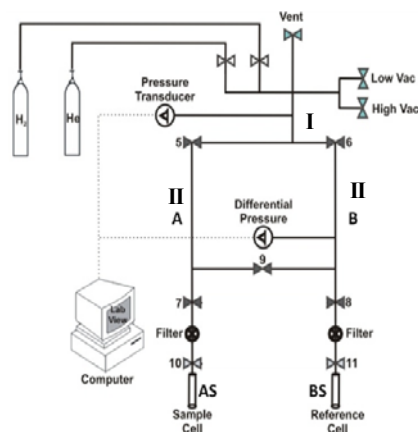

Experimental data for validation, demonstrating different methods.

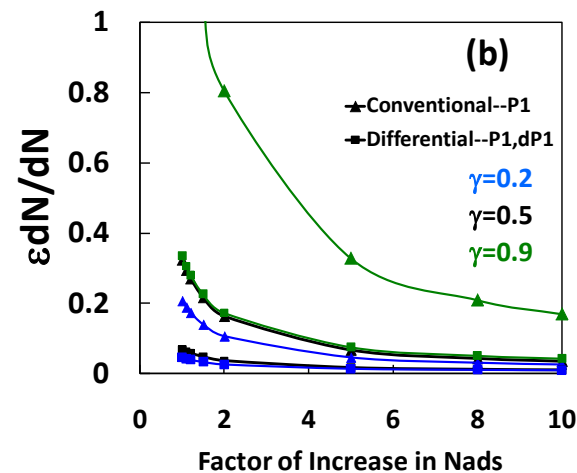

Parametric analysis of differential vs. conventional show, given similar size and transducer precision, differential is AT LEAST 10-fold more precise than conventional.

Collaborations

University:

- Prof. Angela D. Lueking (Penn State) PI, prime
- Prof. Jing Li (Rutgers) Co-PI, sub-contractor
- Prof. Milton W. Cole (Penn State), Co-PI

Collaborations in 2012

- **Badding and Crespi** (PSU, application of in situ characterization methodology developed under BES project to CuBTC and to MOF-N2)
- **George Froudakis, University of Crete** (DFT modeling)

Future Work

- Capitalize on DFT prediction on new molecular catalyst design to reduce kinetic limitations of spillover. Validate with experimental measurements.
- Direct doping of PB-MOF-N2, in an attempt to facilitate kinetics; surface chemistry of MOF-N2 was originally designed to facilitate direct doping
- Explore apparent activation required for PB-MOF-N2.

We will not meet 3.0 wt% by the Go/NoGo, and plan to request a no cost extension so students can finish theses.

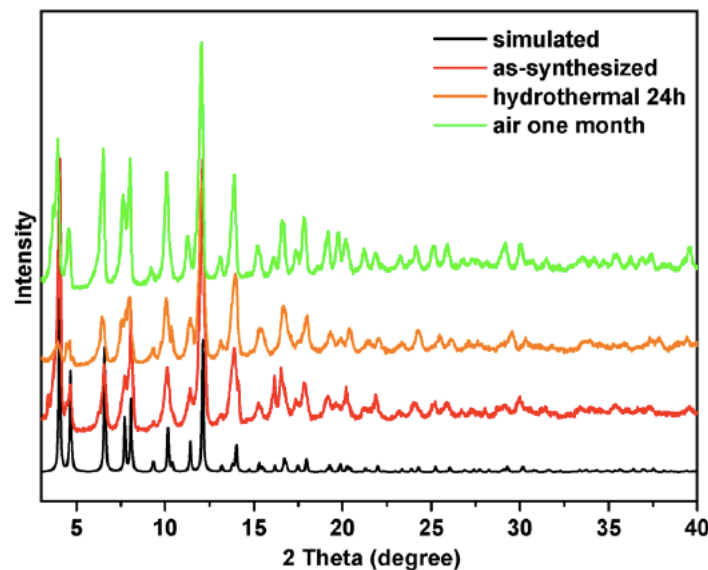
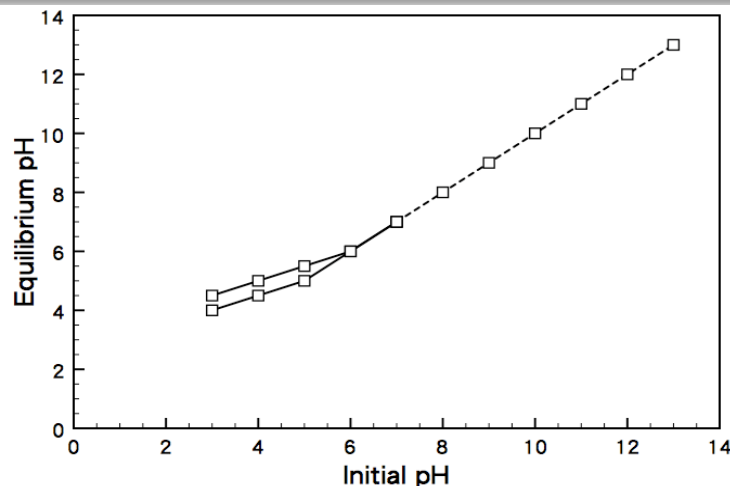

MOF Stability in Water

Project Summary

- One MOF chosen for study in 2012
- Goal is to demonstrate is to realize “full potential” for hydrogenating this MOF, which would lead to 3.25 wt%
- PB doping technique is robust
- Despite promising low P data, high P data is low (<1 wt%) at 80 bar.
- Enhancement is ~20% (average) to 233% (best) relative to MOF-N2.
- However, pressure and history-dependent kinetic limitations are observed, and high activation energies for surface diffusion in MOFs likely limit their uptake via the spillover process
- Spectroscopy suggests reversible hydrogenation of ligand and intact structure after low temperature H₂ exposure

ID	Pretreatment	Pressure (bar)	H2 Uptake (wt%)	
MOF-N2	120 °C, 10 hr	1	0.0126	
	120 °C, 10 hr			
	120 °C, 10 hr	1	0.00518	
	120 °C, 10 hr	1	0.00568	
	120 °C, 10 hr	70	0.35 ± 0.17	
MOF-N2	120 °C, 10 hr	70	0.30 ± 0.07	
PB-MOF-N2, 1-1	120 °C, 10 hr	1	0.0327	
	1-2	120 °C, 4 hr	1	0.0439
	1-3	120 °C, 4 hr		
	1-4	120 °C, 4 hr	1	0.0441
	1-5	120 °C, 10 hr	70	0.48 ± 0.12
PB-MOF-N2, 2-1	120 °C, 10 hr	70	1.008 ± 0.034	
			0.555	
	2-2	120 °C, 10 hr	66	0.28
	2-3	25 °C, 24 hr	70	0.17 ± 0.047
	2-4	After adsorption	9	0.034 ± 0.047
	2-5	120 °C, 10 hr	70	0.33 ± 0.047
	2-6	120 °C, 10 hr	1	0.0264
	2-7	120 °C, 4 hr	1	0.0269
	2-8	120 °C, 4 hr		
PB-MOF-N2, 3-1	120 °C, 10 hr	70	0.55 ± 0.031	
			0.305	
	3-2	25 °C, 10 hr	70	0.24 ± 0.031
	3-3	After adsorption	9	0.199 ± 0.031
	3-4	120 °C, 10 hr	70	0.423 ± 0.031
				0.292
3-5	with and w/o treatment	10	0.0221 ± 0.031	
3-6	120 °C, 10 hr		0.0387 ± 0.028	
			0.274	



Technical Back-Up Slides

Diffusion Estimation

$$D = \frac{1}{z} v_e \alpha^2 e^{-E/kT}$$

Coordination Number z

- 1 linker TDPAT has 45 atoms
- $z = 2$
 - 33 atoms
- $z = 3$
 - 12 atoms
- $\langle z \rangle = \frac{33}{45} \times 2 + \frac{12}{45} \times 3 = 2.27$

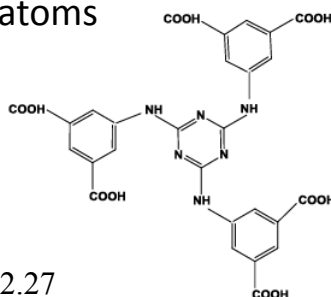

Diffusivity ($E_a = 1$ eV)

$$D = \frac{1}{2.27} \times 7.25 \times 10^{12} \frac{1}{s} \times (1.5 \text{ \AA})^2 \times e^{-1/0.02586}$$

$$= 1.155 \times 10^{-4} \frac{\text{Å}^2}{s}$$

Effective Vibrational Frequency v_e

$$U(x) = \varepsilon(x^{12} - 2x^6)$$

$$\Rightarrow U(r) \approx \frac{1}{2} \cdot 72\varepsilon \cdot \left(\frac{2^{1/6} \sigma}{r} - 1 \right)^2 - \varepsilon = \frac{1}{2} k(x-1)^2 - \varepsilon$$

- Hooke's constant = 72ε

$$v_e = \frac{1}{2\pi} \sqrt{\frac{k}{m}} = 7.25 \times 10^{12} \frac{1}{s}$$

Diffusivity ($E_a = 0.6$ eV)

$$D = \frac{1}{2.27} \times 7.25 \times 10^{12} \frac{1}{s} \times (1.5 \text{ \AA})^2 \times e^{-0.6/0.02586}$$

$$= 602.64 \frac{\text{Å}^2}{s}$$

- The small diffusivity supports the observation of the slow kinetics.