



Empowering The Hydrogen Economy

Presented To

Hydrogen and Fuel Cell Technical Advisory Committee

Marshall Towe
Founder and CEO
Cascadiant Energy
April 2016



Cascadiant Company Profile

- Cascadiant was founded in 2010 as a green energy solutions integrator and managed energy service provider with offices in Singapore, Australia, Bangladesh, Indonesia, Pakistan, Myanmar, Vietnam and Timor Leste.
- Our corporate mission is to provide turnkey, highly reliable power and clean energy solutions through the integration of the latest green technologies to reduce a customer's carbon footprint as well as immediately lower overall operating costs associated with power and energy.
- Cascadiant has implemented and manages more stationary fuel cell sites than any other company, providing over 2 million hours of energy and producing in excess of 5,300 megawatts of clean power while abating more than 17,000 tons of carbon.
- Since 2013 Cascadiant has had a R&D partnership centered around fuel cell technology with Indonesia's technology agency BPPT.
- Commercial projects completed or ongoing in 8 countries: Australia, Israel, Bangladesh, Indonesia, Nigeria, Pakistan, Timor Leste and Vietnam.
- Cascadiant has developed its own energy monitoring solution; integrated off grid fuel cells with PV; designed and deployed stand alone 2,000 liter fuel tanks; integrated fuel cells with Li-ion batteries: and developed a containerized portable DI water and ME mixing plant.



Speaker Profile

- Founded Cascadian in 2010 with Asia based venture capital.
- Founded GreenFleets USA in 2009 with BYD of China and Veolia USA to deploy 500 e-taxis in the top 20 cities. Recognized by Clinton Global Initiative in 2009. BYD failed to deliver promised e6 cars and GreenFleets suspended operations Dec 2009. BYD Uber trials began 2016 in Chicago.
- Member of founding team of Better Place in 2007. Electric car company based on battery exchangeable vehicles in partnership with Renault/Nissan and large power utilities. OpCo's launched in USA, Israel, Denmark and Australia. Company folded in March 2013 after deploying 2,000 cars.
- Corporate Vice President and Managing Director QUALCOMM South Asia; Vice President and President VeriSign Asia—1997 to 2007.
- Operational, M&A and Engineering roles at Motorola, MCI, NORTEL and GTE—1981 to 1997.
- Founding board member of Mobile 8 (now Smart) wireless company in Indonesia; member of advisory board of University of Illinois Chicago; founder and chairman Singapore International Jazz Festival; board advisor Java Jazz Festival in Jakarta; board member of ASEAN Technology Center; board member Sustainable Philanthropy.



2013–2015 Data Points

- The wireless industry added nearly 1,000,000 off-grid sites using over 1.3 million diesel generators.
- These 1.3 million diesel generators emit nearly 100 million tons of CO₂ each year.
- This represents the equivalent CO₂ of 20 million automobiles.
- The wireless industry also adds or replaces an additional 500,000 diesel generators each year for back-up power that run an average of 4 hours per day.
- Indonesia, the 4th largest telecom sector, added and replaced nearly 10,000 diesel generators in their networks but have just over 600 Fuel Cells and less than 400 PV Solar Sites.
- Indonesia telecom sector emitted an estimated 60,000,000 metric tons of CO₂ through its diesel generator use alone.

Spotlight on Indonesia – Fuel Cell Opportunity

- Indonesia has become the 12th largest emitter of CO₂ in the world approaching 500,000,000 metric tons per year.
- In 2014 Indonesia became the 19th biggest importer of oil and is expected to be one of the top 10 biggest importers of oil by 2020.
- In 2014 oil imports cost to the Indonesia economy over \$35B USD.
- According to Wood McKenzie Consulting Indonesia will be the world's largest importer of gasoline by 2018.
- In 2014 Indonesia's telecom industry consumed nearly 80,000,000 liters of diesel fuel to support back up and off grid power needs.
- In 2016 Indonesia's telecom sector will spend and estimated \$425,000,000 USD associated with back-up and off-grid power including diesel fuel, diesel generators and spare parts to keep them operational. 75% of this amount directly tied to equipment and fuel purchases outside Indonesia.



Hydrogen Economics That Can Work



Why Hydrogen Won't Work

“In order to have a hydrogen economy, we must first have a hydrogen highway with H₂-powered vehicles traveling upon it. For this to happen the infrastructure, such as hydrogen fueling stations have to be in place. Billions of dollars would be wasted.” *H2-Economy.com*

“The advantages of hydrogen praised by journalists (non-toxic, burns to water, abundance of hydrogen in the Universe, etc.) are misleading, because the production of hydrogen depends on the availability of energy and water, both of which are increasingly rare and may become political issues, as much as oil and natural gas are today.” “*Why a hydrogen economy doesn't make sense.*” Ulf Bossel PhysOrg.com

“Almost everyone supports a hydrogen economy -- conservatives and liberals, tree huggers and oil drillers. Such unanimity forecloses serious discussion. That's unfortunate. An aggressive pursuit of a hydrogen economy is wrongheaded and shortsighted.” *David Morris vice-president of the Institute for Local Self Reliance*

Its just too hard, too costly, will take too long, and not needed



Significant Upside In Early Adoption

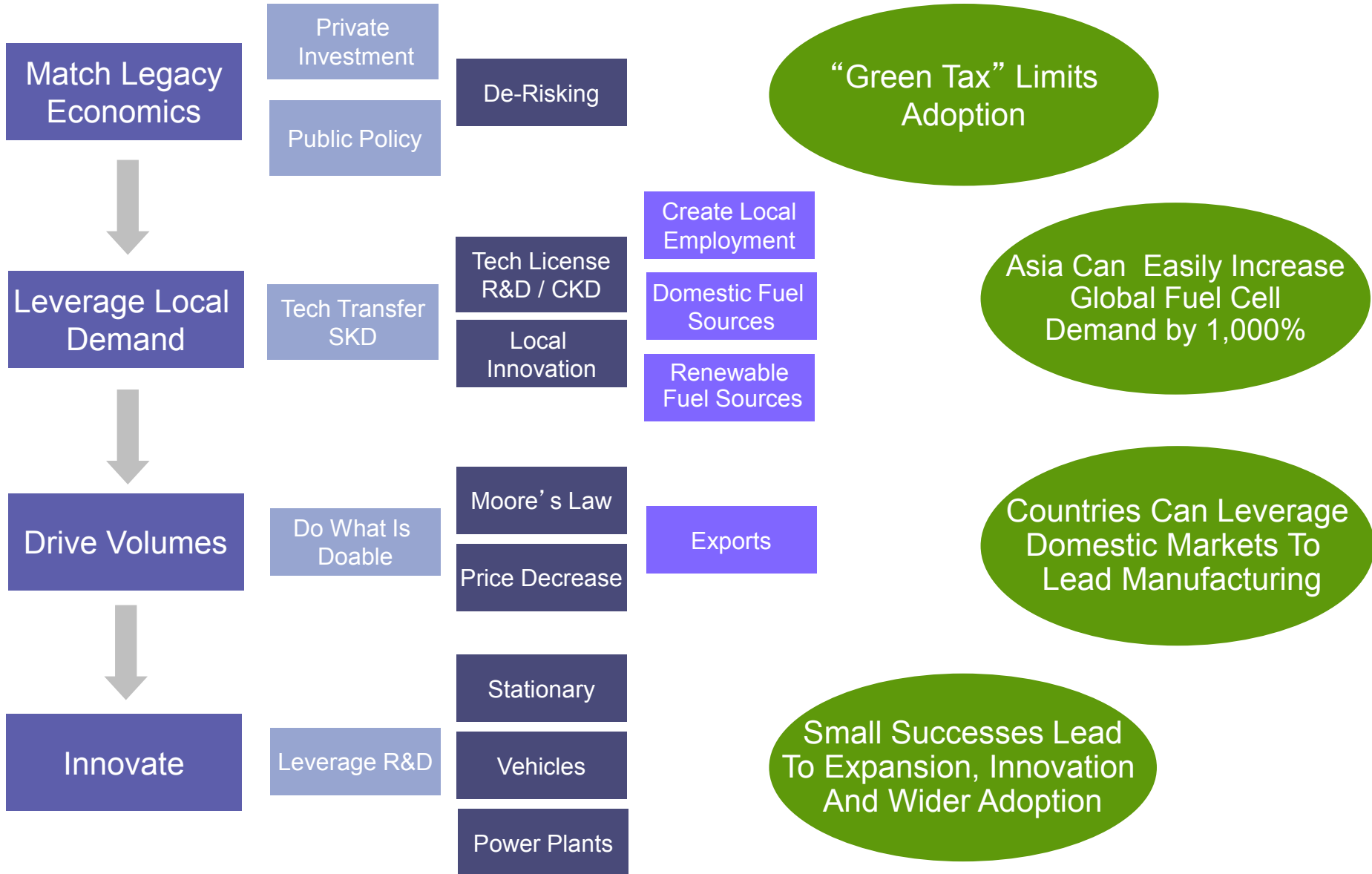

Risks Of A Hydrogen Economy Solved With A Managed Service

Oil Price Increases Will Increase OPEX Costs Of Legacy Solutions

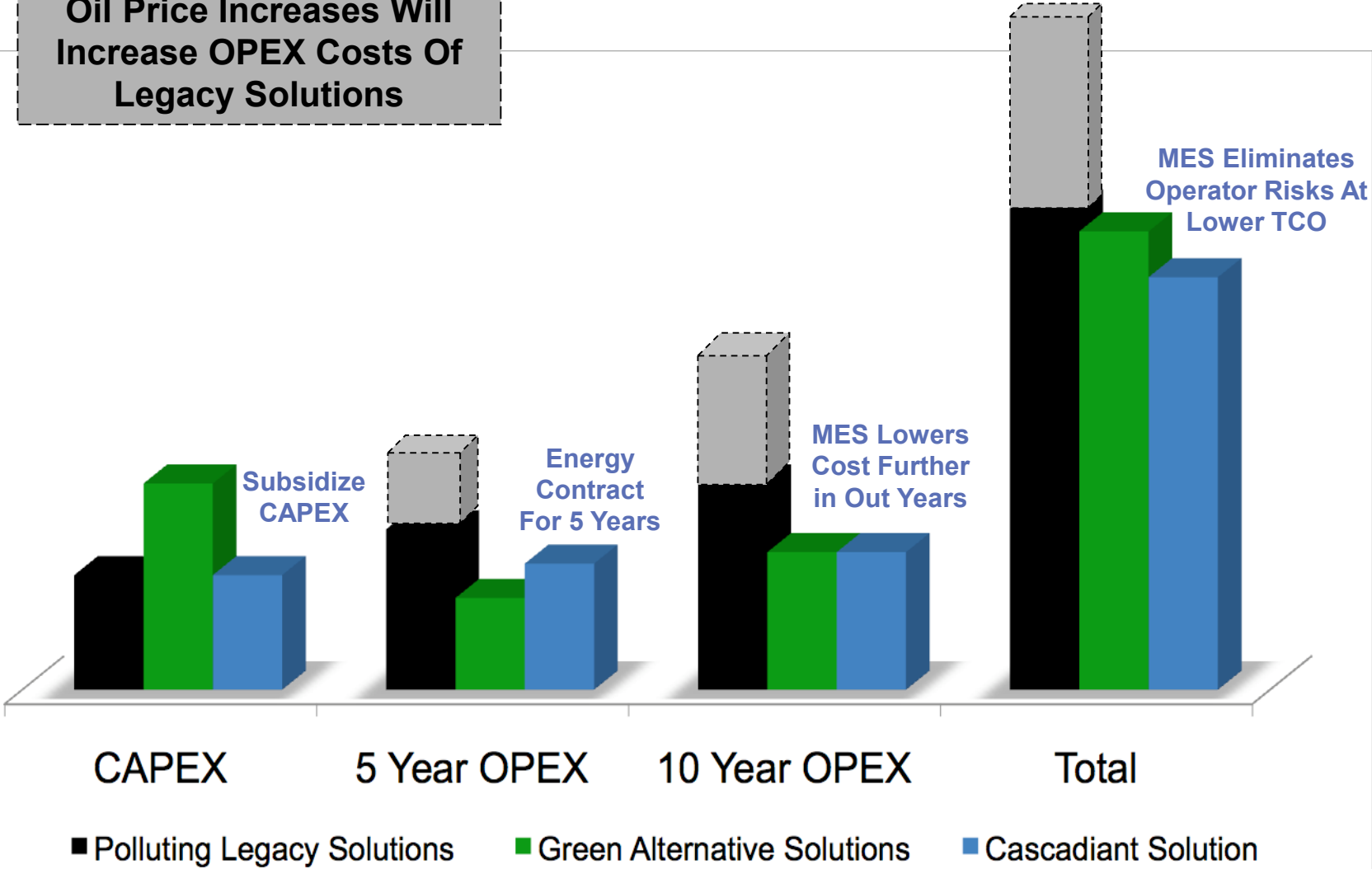



Commercially Viable Hydrogen Solution



Managed Energy Service Benefits

Cascadian provides an integrated power solution using our Managed Energy Service (MES) with an upfront subsidized or eliminated CAPEX and a fixed priced long term energy contract

- **MES Using Methanol Based Fuel Cells At The Core**

- Long-term Fixed Energy Contract
- Guaranteed availability and power levels
- Service Level Agreement Guarantee and Key Performance Indicators
- Network Operations Center (NOC)
- Includes fuel and refueling services

- **Integration of Additional Products and Services**

- Advanced cooling systems that reduce climate energy consumption by more than 60%
- Site energy monitoring and control solutions that reduces overall site power by up to 50%
- Managed Battery Service (MBS) using green batteries
- PV Solar and Wind Products

- **All Products and Services Are Bundled Into A Single Financial Package With A Mixture Of CAPEX and OPEX**



Cascadian Zero CAPEX Energy Solution

Flat OPEX Fee for 60 Months

- Monthly Energy Contract designed on specific customer requirements by site including:
- Fuel Cell installed (all logistics, duties and taxes)
- All equipment, services and maintenance for 5 yrs
- 5yr warranty for all system parts, labor and spares
- All fuel required for 5 yrs
- All fuel delivery and logistics for 5 yrs
- Remote monitoring of Cascadian solution for 5 yrs
- All logistics and warehousing services

Economic and Environmental Benefits

- Zero capital expenditures or down payments
- Monthly OPEX fee remains fixed for 60 mos
- Operator freezes cost for back-up power for 5 years
- Zero emissions (NO_x, SO_x, Particulate)
- Silent Operation – eliminates community issues
- Uses domestic fuel in most cases
- Meets need to deploy green energy
- Can be installed on rooftops

No Risk Solution

- Guaranteed SLA that exceeds any genset
- Cascadian takes full responsibility to replace any stolen parts
- Cascadian takes full responsibility for all fuel theft
- Contract has no price escalation clauses – operator back-up power costs are fixed for 5 yrs
- Contract includes all equipment, fuel and services for 5 yrs – operator has no unexpected costs
- Full hedge against oil price and inflation spikes

Other Power Options

- Can include battery function for full site battery replacement / elimination
 - Guaranteed up to 4hrs back up for 5 yrs
 - No CAPEX and Flat OPEX
 - Cascadian takes battery theft responsibility
- Can include full site monitoring for energy
- Can include services on additional equipment such as rectifiers, utility line grooming, etc.
- Can include smart metering equipment and services



Solution Topology For Energy — Telco

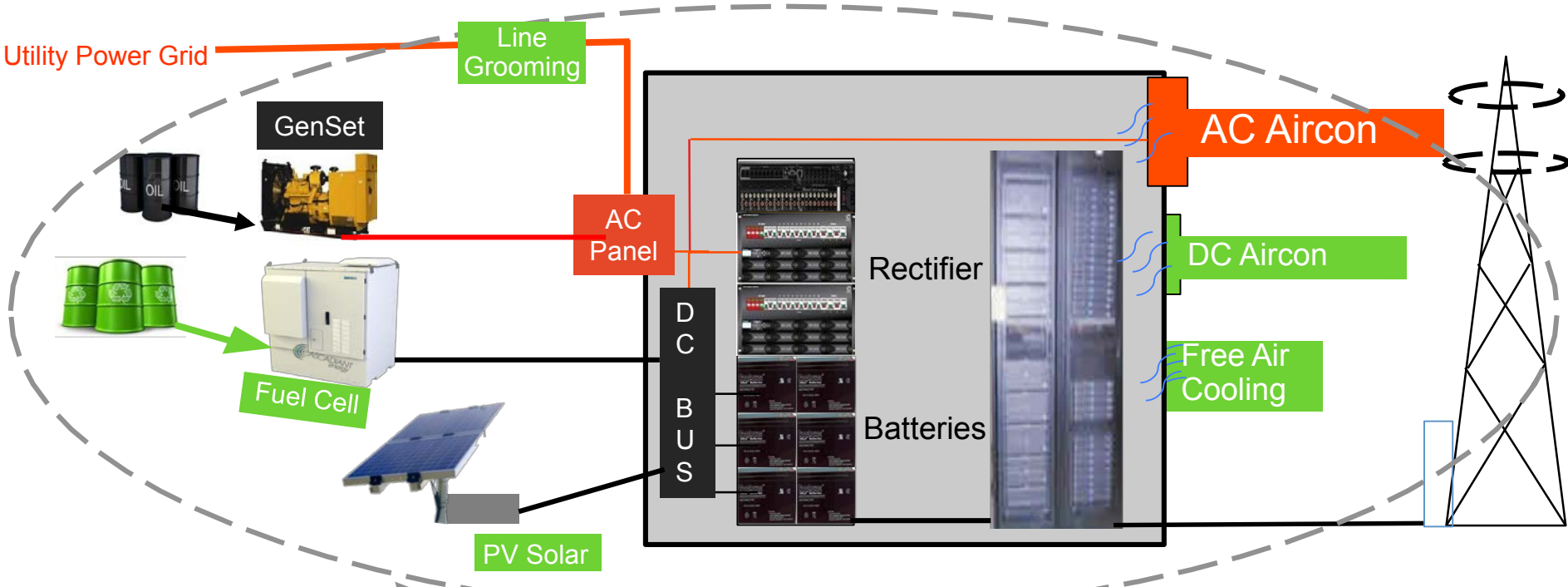

Any standard sensor
RS485; 10V; PT 100
RS232; Modbus, 20mA

Advanced Reporting
Smart Meters
Utility Bill Verification



Diesel Fuel Sensor
Humidity / Water
Door / Smoke Alarm
Aviation Light Fault
Web Cam / Security

AC Energy Grid
DC Energy / DC Bus
Temperature Probe
Battery Probe

GenSet
Fuel Cell
VRLA Batteries
LiOn Batteries
Solar / Wind

ATS-DG
Aircon (AC/DC)
DC Fans
HVAC

Cascadian Indonesia Fuel Cell Innovations







Cascadian has developed a full suite of remote monitoring and control and innovated the use of extended 2,000 liter tanks as well as the integration of PV, batteries, wind and fuel cells for off-grid applications



Hydrogen Economy In The Real World

Cascadian was chosen by Telin to provide the Managed Energy Service (MES) for their green field 3G network deployment in Timor Leste.

- World's First Fully Green Power Network Using PV/Methanol Fuel Cells.
- Fully Integrated Managed Energy Service Solution.
- Highest Reliability For The Power Network With An SLA of 99.35%.
- Awarded November 2012 and Expanded in 2013. Runs through 2017.

CONFIGURATION	
Site Type	Solution Type
 Grid Connected – End Site	EDTL and Fuel Cell
 Grid Connected – Backbone	EDTL and Fuel Cell and Advanced Cooling Systems
 Off Grid – Accessible – End Site	Fuel Cell and PV Hybrid
 Off Grid – Accessible - Backbone	Fuel Cell and PV Hybrid and Advanced Cooling Systems
 Off Grid – Limited Accessibility – End Site	PV and Battery
 Off Grid – Limited Accessibility - Backbone	PV and Battery and Advanced Cooling Systems





Tower Sharing – The NEXT Opportunity

- As tower sharing grows, the Fuel Cell addressable market increases five-fold

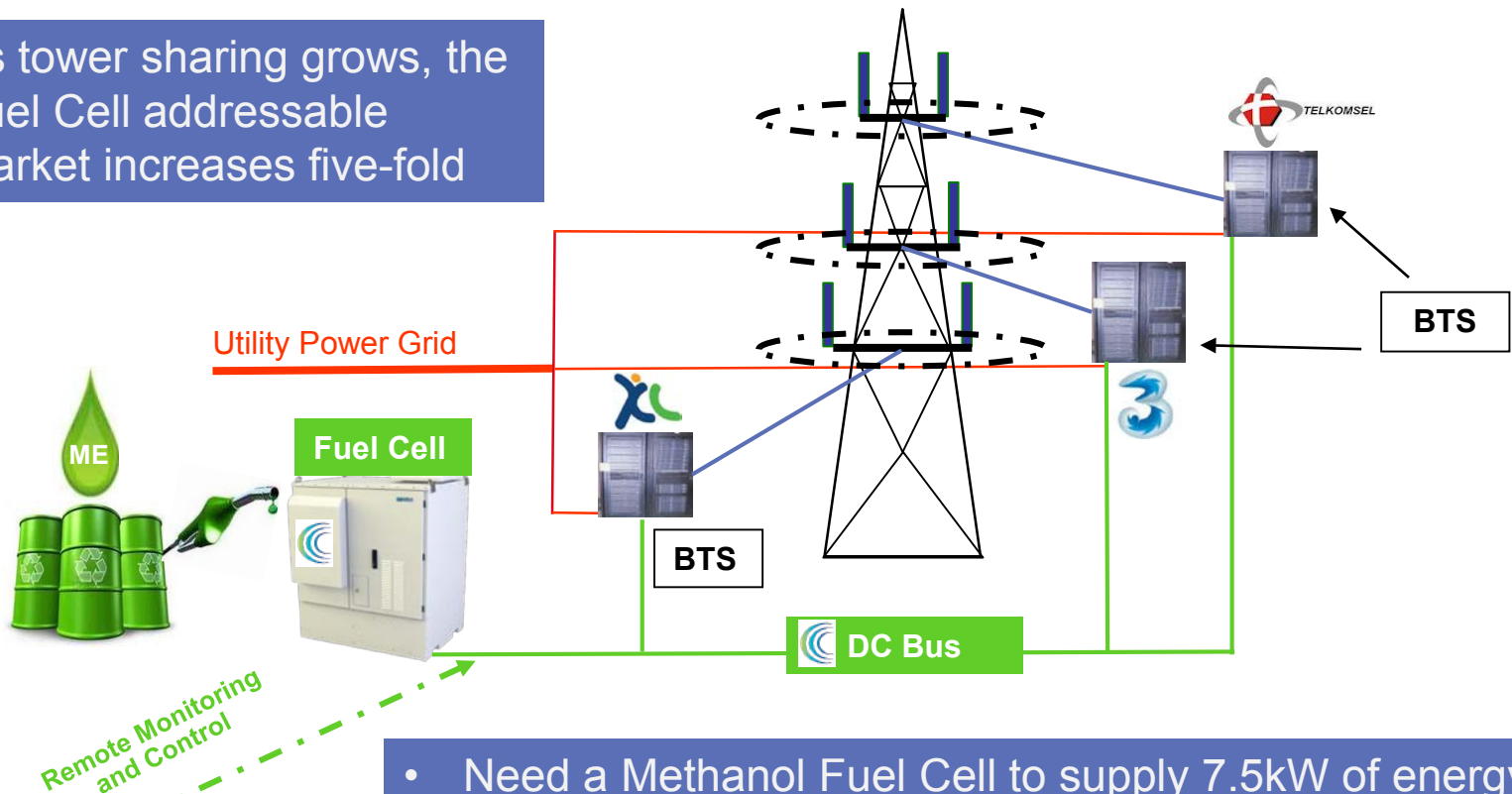

Remote Monitoring and Control



Cascadian NOC

- Need a Methanol Fuel Cell to supply 7.5kW of energy
- Power must be completely independent and insulated between customers
- Fuel Cell to simultaneously produce 48V and 24V
- Solution can be used to completely eliminate the operator's use of VRLA batteries from site
- Fully networked and remote monitored with a 99% SLA





Overcoming Risks with Full Service Ecosystem



Network Support Capability – Localize Talent

- Cascadiant Network Operation Center (NOC) is a 7/24 information and communication center that connects all facets of the Cascadiant power solution
- Monitors and controls how much energy is available and required within each site
- Intelligently optimizes which element can and should be charged or utilized and at what rates to ensure optimal performance and availability
- Dispatches field service and fuel delivery as required
- Monitors individual, customer defined data points per site

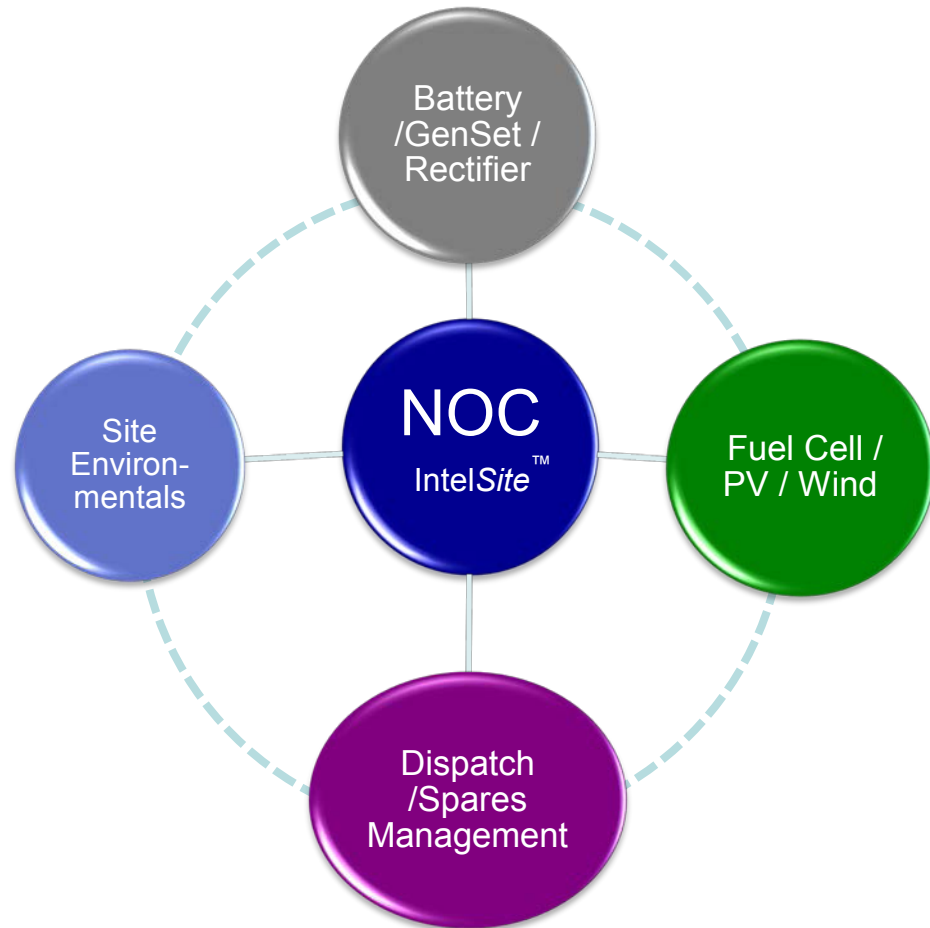

24hr NOC and Help Desk – Locally Staffed

- Remotely monitors all deployed systems
- Interface with Tier 3 OEM's service and engineering organizations
- Coordinates field engineering dispatch
- Interface with operator's NOC
- Coordinates fuel dispatch



Cascadian's In-house Developed Monitoring System

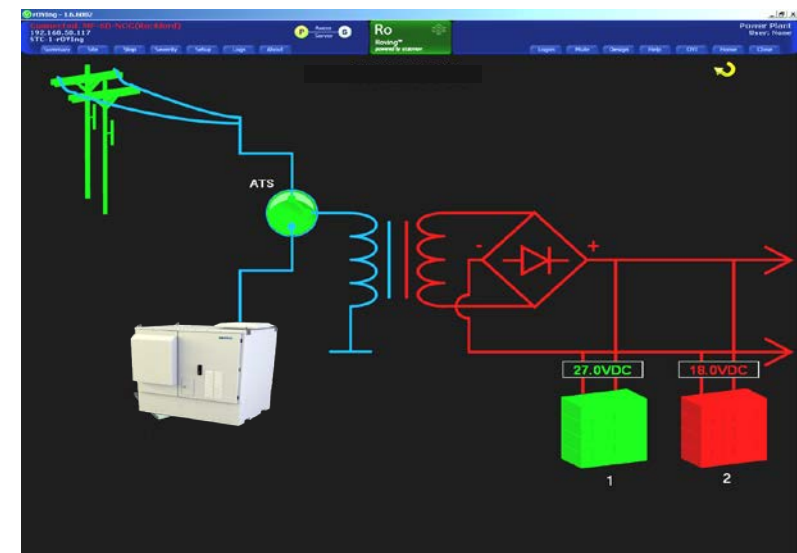
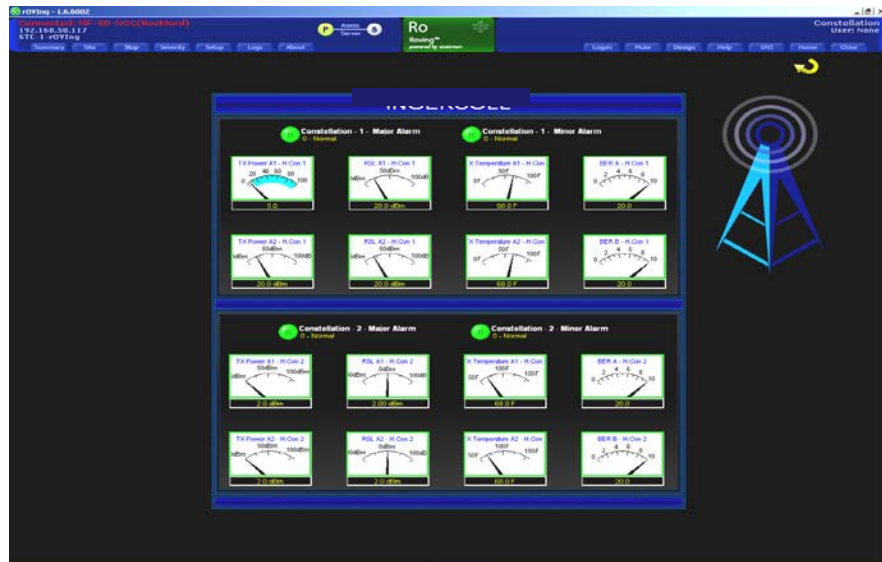
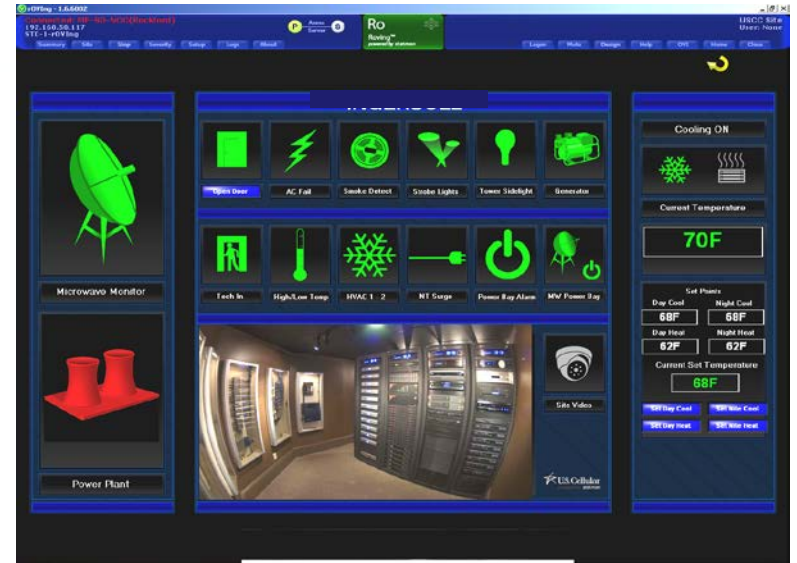
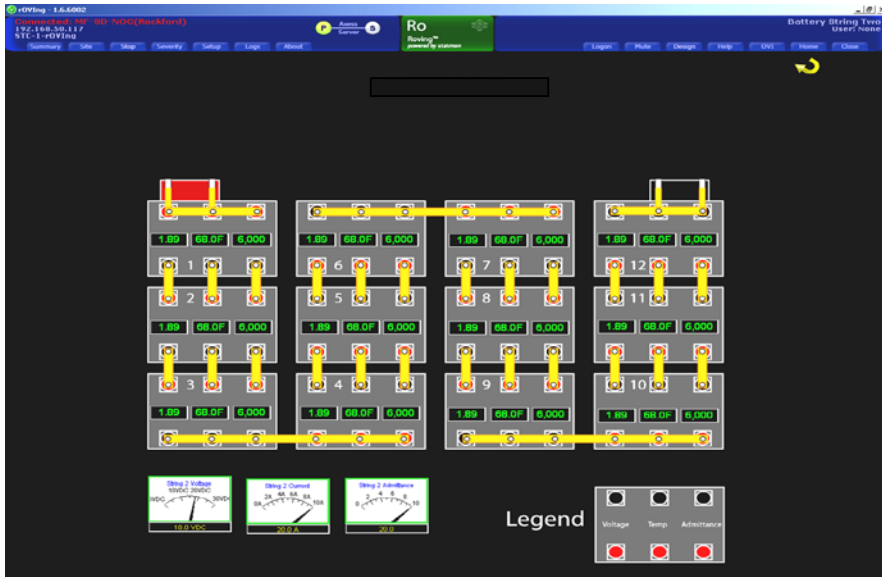

Cascadian's Fuel Network – Indonesia Example



KEY DATA POINTS

- All fuel locally sourced in Indonesia
- 3 Methanol / HydroPlus Suppliers
- 3 Main Fuel Storage Warehouses
- 10 Distributed Fuel and Spares depots
- 12 Field Service Engineering Offices



Mobile Refueling

Half Ton Fully Customized Commercial Trucks



Mobile Blending Unit





SUMMARY



How Does Green Become Solution Of Choice

Look Back To Go Forward

- 1859 in France Étienne Lenoir invented the first Internal Combustion Engine
- Entrenched, institutionalized and powerful political and economic forces
- Green tech must realize that competition is legacy fossil fuel systems not other green technologies
- Consumers and companies want the safe and predictable choices

Overcome “Risks Are Too Many” and “Easier To Use Status Quo”

- Technology
- Future Costs
- Performance
- Unfulfilled Promises and Unrealized Gains
- Dependence on government subsidy is not economically viable

Advantages - Its Going To Happen Eventually

- Technology improvements - while slow, occur every day
- Costs - declines are inevitable as volumes increase but vendors must take risk to accelerate demand
- Performance - long term superior performance data increases daily
- Industry must stop over promising

Easiest Way To Eat An Elephant - One Small Bite At A Time!





Thank You

